

Response Wirefree Alarm Systems

SA1 BASIC FUNCTION

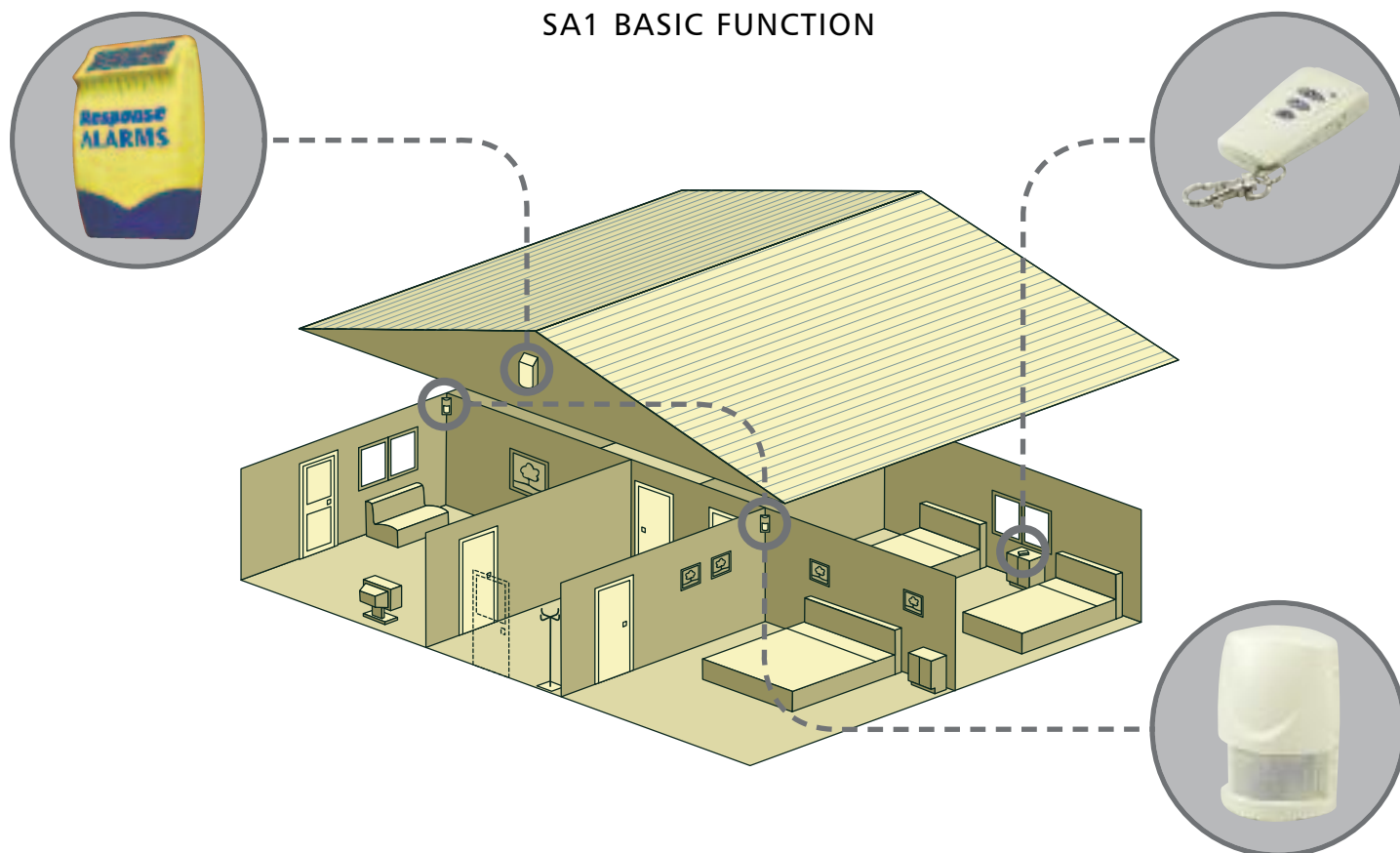

Features:

- Low battery indicators
- Anti-tamper and jamming
- Personal Attack facility
- Single zone control unit (within Solar Siren)
- Battery powered Solar Siren with comfort LEDs
- Operates for up to 25 days in standby without sunlight
- Walk test facility on PIR movement detectors
- Entry and exit delay option

SYSTEM	KIT CONTENTS	INSTALLATION TIME [†]	EASE OF INSTALLATION ^{††}
SA1	1 x External Solar Siren, 2 x PIR Movement Detectors, 1 x Remote Control, Batteries, Fixings and Manual	1 ½ Hours	●●●●●

[†]Guideline only

^{††}Scale 1-5, 5 being the easiest

Response Wirefree Alarm Systems

SA2 BASIC FUNCTION

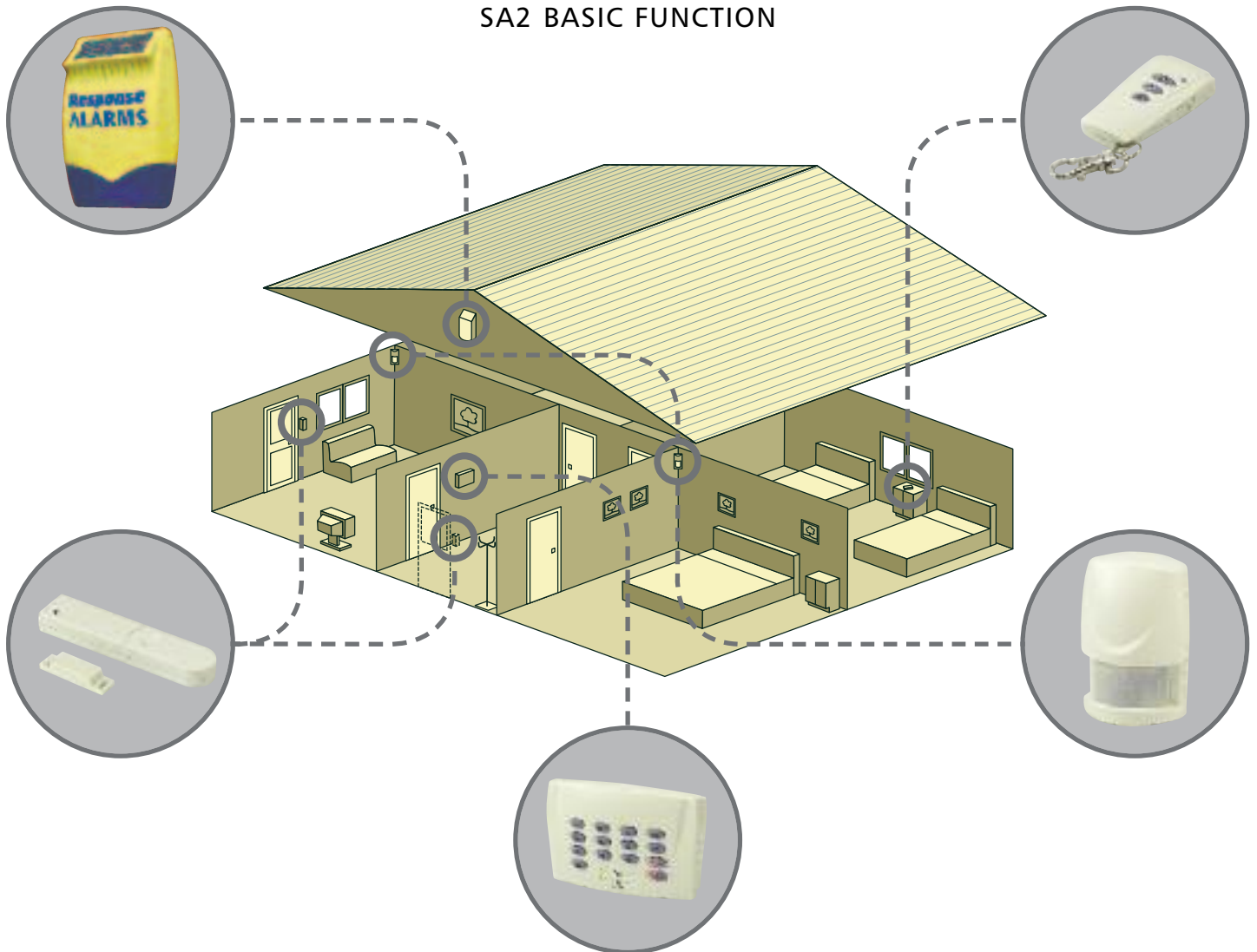

Features:

- Low battery indicators
- Anti-tamper and jamming
- Personal Attack facility
- Single zone control unit (within Solar Siren)
- Battery powered Solar Siren with comfort LEDs
- Operates for up to 25 days in standby without sunlight
- Walk test facility on PIR movement detectors and magnetic door contacts
- Entry and exit delay option

SYSTEM	KIT CONTENTS	INSTALLATION TIME [†]	EASE OF INSTALLATION ^{††}
SA2	1 x External Solar Siren, 2 x PIR Movement Detectors, 2 x Magnetic Door Contacts, 1 x Remote Control, 1 x Keypad, Batteries, Fixings and Manual	2 Hours	●●●●●

[†]Guideline only

^{††}Scale 1-5, 5 being the easiest

Response Wirefree Alarm Systems

SA3 MEDIUM FUNCTION

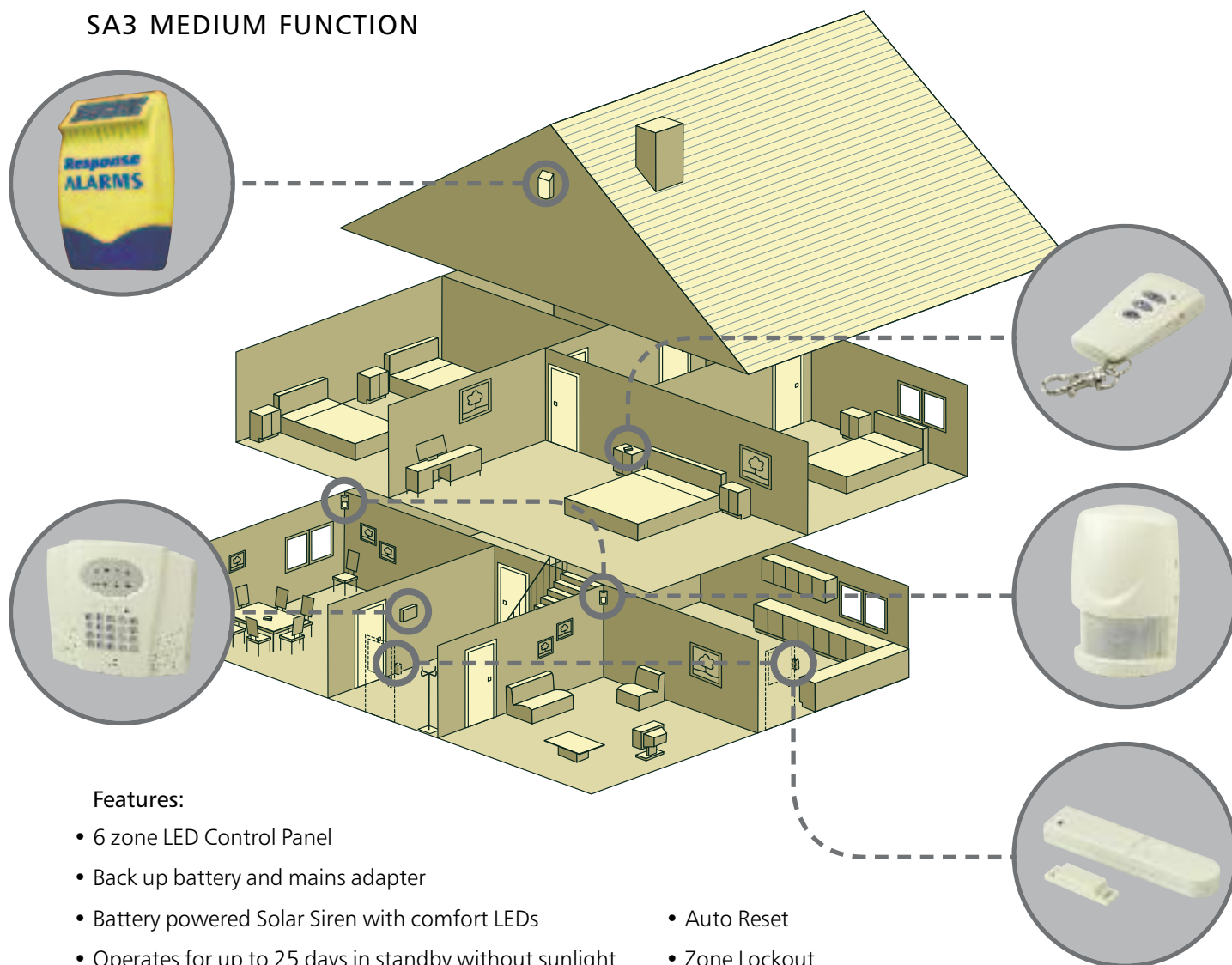

Features:

- 6 zone LED Control Panel
- Back up battery and mains adapter
- Battery powered Solar Siren with comfort LEDs
- Operates for up to 25 days in standby without sunlight
- Low battery indicators
- Instant or delayed alarm zones
- Entry/Exit Delay warning (selectable)
- Internal Siren
- Connections for hardwired siren and autodialler
- Programmable 4 digit user code
- Programmable alarm duration
- Auto Reset
- Zone Lockout
- Programmable Entry/Exit Delay
- Siren Disable (selectable)
- Anti-tamper and jamming
- Personal Attack facility
- Walk test facility

SYSTEM	KIT CONTENTS	INSTALLATION TIME [†]	EASE OF INSTALLATION ^{††}
SA3	1 x External Solar Siren, 1 x LED Control Panel, 2 x PIR Movement Detectors, 2 x Magnetic Door Contacts, 1 x Remote Control, 1 x Plug In Power Supply, Batteries, fixings and manual	3 Hours	●●●●

[†]Guideline only

^{††}Scale 1-5, 5 being the easiest

Response Wirefree Alarm Systems

SA5 ADVANCED FUNCTION

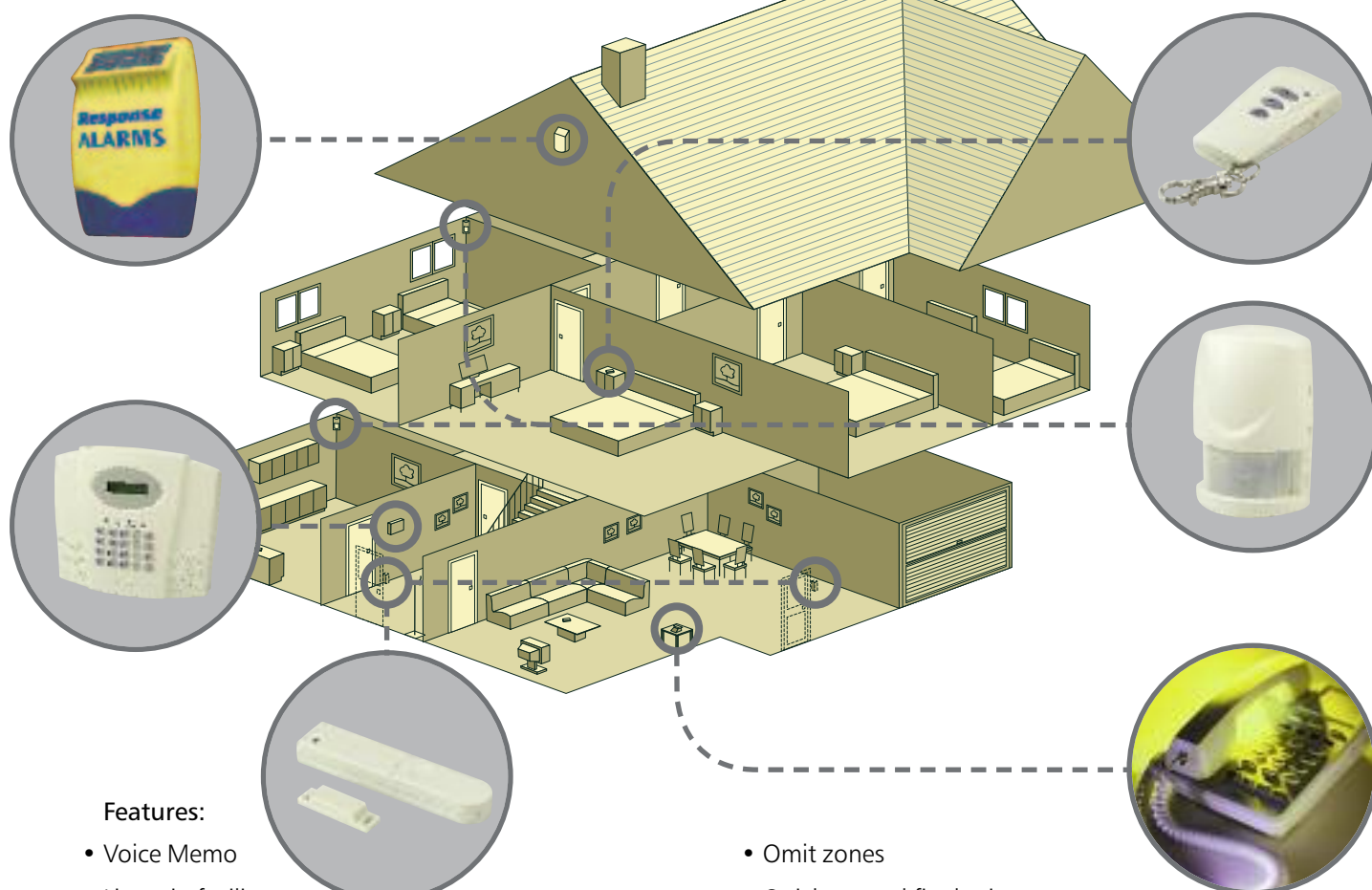

Features:

- Voice Memo
- Listen in facility
- 6 Users + Master User
- Latch Key – children home
- Remote System Access via phoneline
- 10 zone LCD control Panel (6 wirefree and 4 wired zones)
- Back up battery and mains adapter
- Battery powered Solar Siren with comfort LEDs
- Operates for up to 25 days in standby without sunlight
- Telephone Voice Dialler
- Answering machine
- Low battery indicators
- Omit zones
- Quick set and final exit set
- Walk through zones
- Independently programmable entry and exit delays
- Programmable alarm duration
- Anti-tamper and jamming
- Personal Attack facility
- Zone lockout
- Chime
- Internal Siren
- Walk test facility

SYSTEM	KIT CONTENTS	INSTALLATION TIME [†]	EASE OF INSTALLATION ^{††}
SA5	1 x External Solar Siren, 1 x LCD Control Panel, 2 x PIR Movement Detectors, 2 x Magnetic Door Contacts, 1 x Remote Control, 1 x Plug In Power Supply, Batteries, fixings and manual	4 Hours	●●

[†]Guideline only

^{††}Scale 1-5, 5 being the easiest

Response Wirefree Alarm Systems



MyGARD Remote Security Manager

Monitor the Safety of your Premises for a few £s a Year

Now, for a few pounds a year you can, with an SA5 intruder system, have your home or business monitored by **MyGARD Safe & Secure** in conjunction with one of the world's largest security companies – **Group 4 Total Security**.

You will want to do everything to keep your family safe and their possessions secure – MyGARD Safe & Secure brings you that peace of mind.



Using **MyGARD Safe & Secure** monitoring managed by **Group 4** you can personally select to the day, hour and minute when you want the security of your property monitored – and you should be contacted in the case of an incident. It is simple, and you decide.

You can choose to have your property monitored 24 hours a day or for any period of time specified by yourself. You may decide to have monitoring only whilst out at work, perhaps when away on a holiday break or over the weekend when your business is closed – you can simply and quickly change your monitoring instructions either on the Internet via your password protected personal Security Folder or by post. And when your property isn't being monitored the SA5 system will still operate as a bell-only alarm.

Additionally you can decide who at any particular time is informed of an incident. For example you may wish neighbours, staff or family along with yourself to be informed by telephone, mobile phone, text message or e-mail if there is a problem in the daytime. During the night or whilst you are away you may want a different group of people informed or request that **Group 4 Total Security** attend – you can have peace of mind that the problem will be professionally and efficiently dealt with by a **Group 4 Mobile Officer**.

The **MyGARD Safe & Secure** monitoring system is simple and highly flexible and puts you totally in control of your family's and business security needs for an unbelievably low annual fee.

This service is not provided by Response. For more information on MyGARD Safe & Secure, please call: 0870 9040222 or visit www.mygard.com

Response Wirefree Alarm Systems

Product Selector

ALARM KITS	
SA1	1 x External Solar Siren, 2 x PIR Movement Detectors, 1 x Remote Control, Batteries, fixings and manual
SA2	1 x External Solar Siren, 2 x PIR Movement Detectors, 2 x Magnetic Door Contacts, 1 x Remote Control, 1 x Keypad, Batteries, fixings and manual
SA3	1 x External Solar Siren, 1 x LED Control Panel, 2 x PIR Movement Detectors, 2 x Magnetic Door Contact, 1 x Remote Control, 1 x Plug In power Supply, Batteries, fixings and manual
SA5	1 x External Solar Siren, 1 x LCD Control Panel, 2 x PIR Movement Detectors, 2 x Magnetic Door Contact, 1 x Remote Control, 1 x Plug In power Supply, Batteries, fixings and manual

ALARM ACCESSORIES	
SU1	2 x Door Contacts, 1 x Remote Control
SU2	2 x PIR
SU3	2 x Remote Control
SU4	2 x Door Contacts
SU5	1 x Keypad
SU6	1 x Solar Siren
SU8F	1 x Smoke Detector

Response Wirefree Alarm Systems

The Response Wirefree Alarm Systems offer internal space protection by monitoring entry points and the interior of the property. To attain maximum coverage, and to prevent false alarms there are a number of rules to follow when installing detectors.

Installation hints and tips

Example of coverage in a two storey family home.

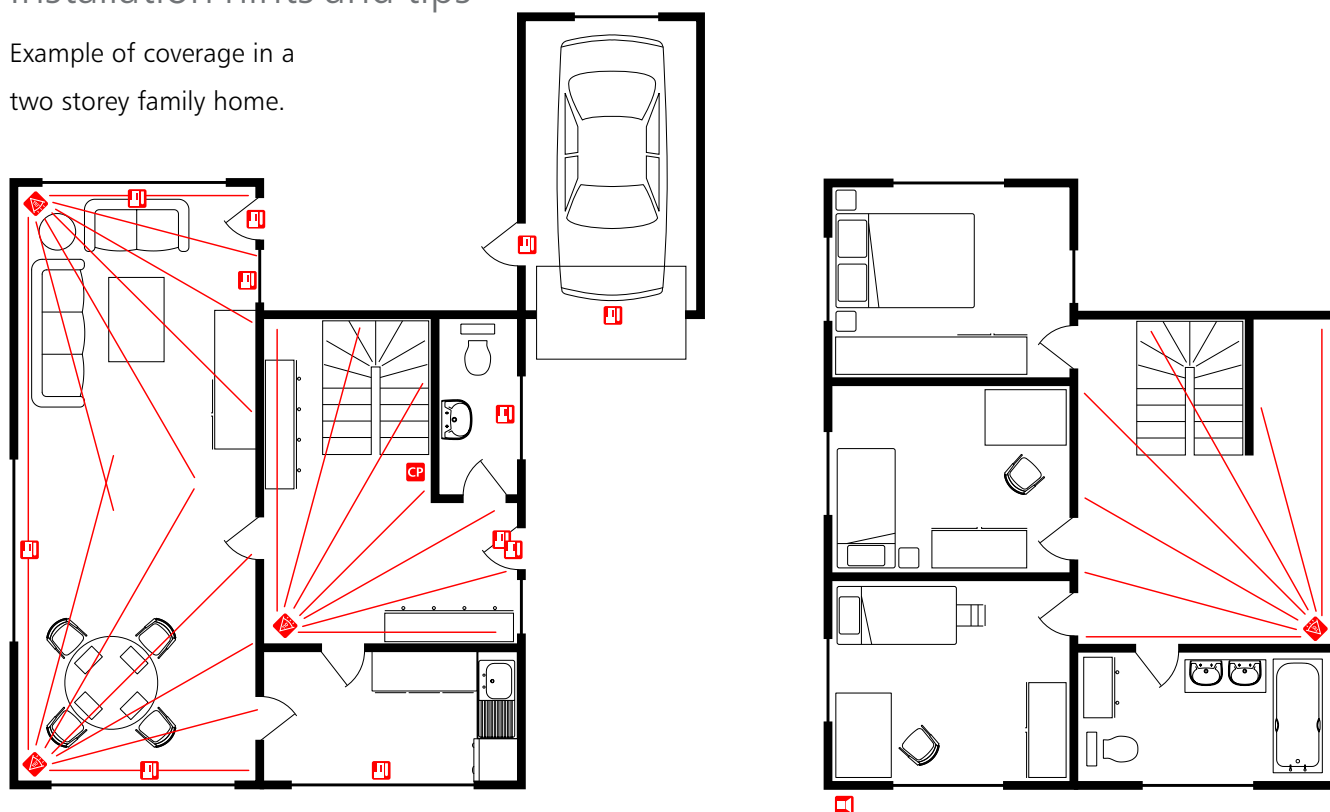

-  PIR Movement Detector
-  Control Panel
-  Solar Siren
-  Magnetic Contact

Response Wirefree Alarm Systems

Installation hints and tips

PIR detectors may be wall or corner mounted by applying different knockouts.

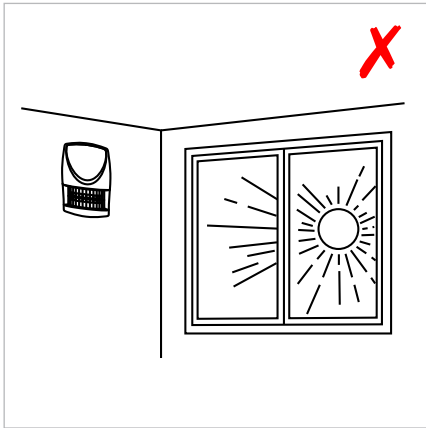

Do not install where the detector is in or facing direct/reflected sunlight or strong draughts/heaters)

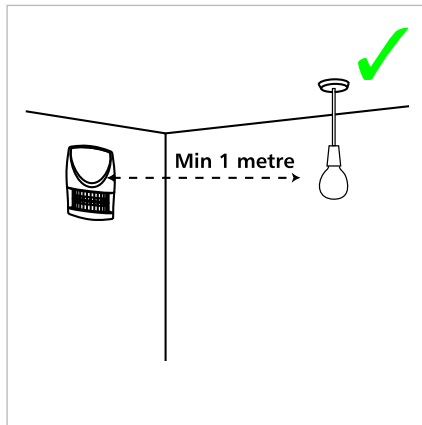

Locate the detector at least one metre away from any illumination, to avoid possible interference

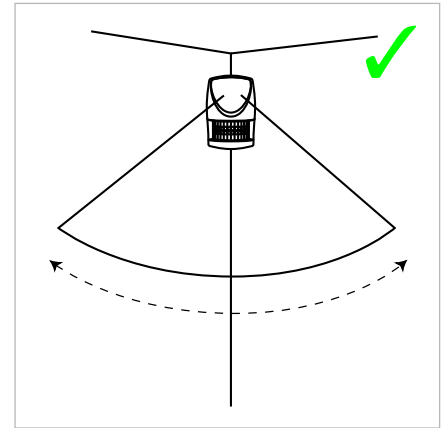

Mount in the corner of a room. PIR detectors are more sensitive to motion passing across the detection zones than toward the unit

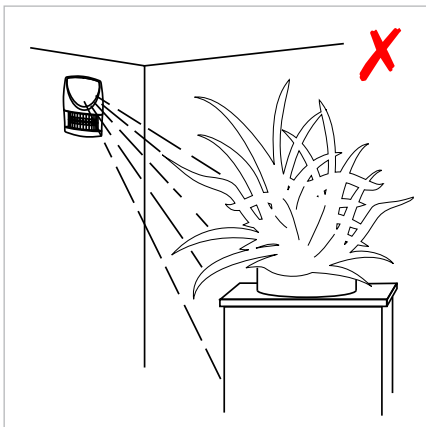

Ensure that there are not any obstructions (plants, screens, furniture etc.) in the field of view which may cause incorrect cover/operation of the detector

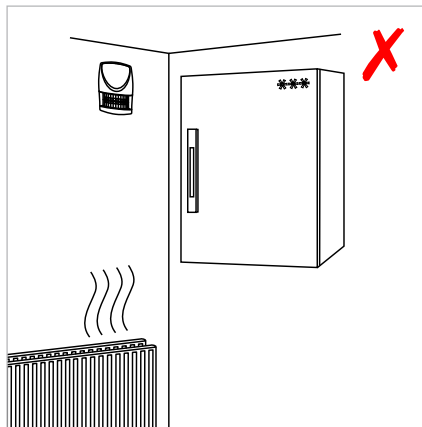

Avoid locating the detector in areas which contain equipment that may change the environment temperature rapidly. For example: above radiators

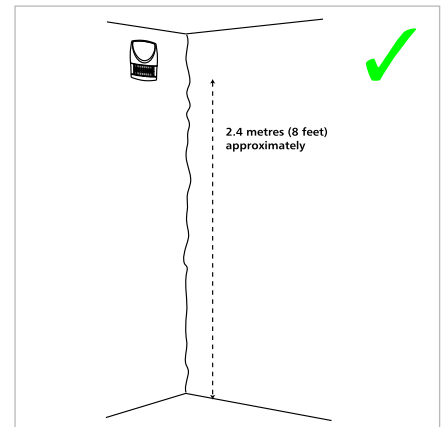

Install the detector at the recommended height on a rigid, even surface

Mini Alarm



Friedland Mini Alarm is a range of individual components which can be used together or singularly. The range includes window alarms, entry alarms, motion alarms and personal alarms.

Features and Benefits:

- Easy installation, independent wirefree window alarm and entry alarm
- Door contacts are prewired for approximately 2 metres
- Simple operating instructions, motion alarms incorporate operating keypad, alternatively a remote control option is available
- The Personal Alarm, Door Stop Alarm and Portable Alarm are ideal for use when travelling
- 2 year guarantee